

Framsida

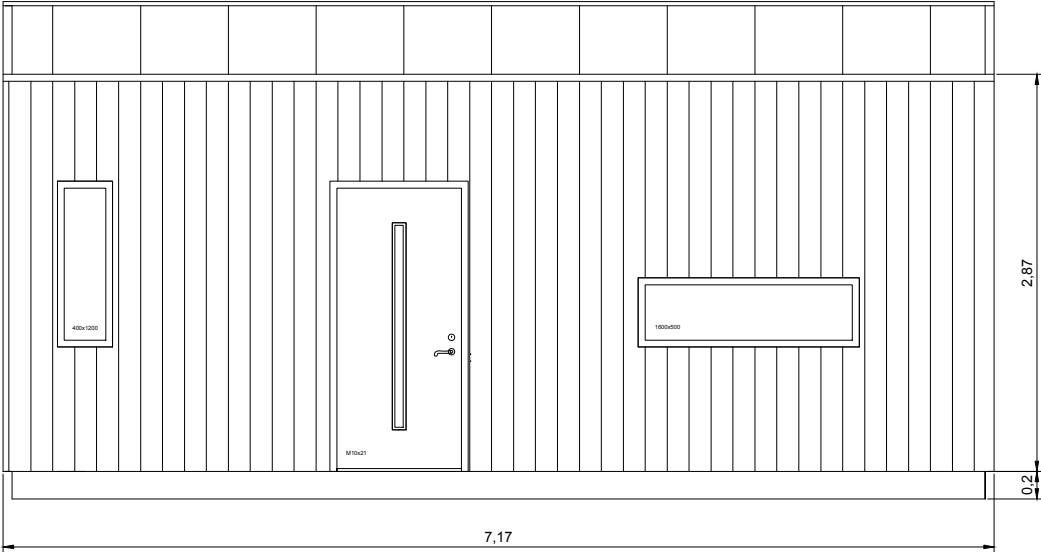

meter

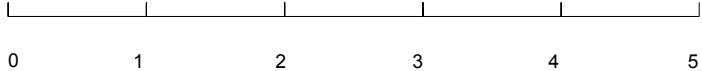

Planritning

Ritningar nr. A001

Rev.

23/02

Skals 1:100

Ritad: Hus i bergslagen

Baksida

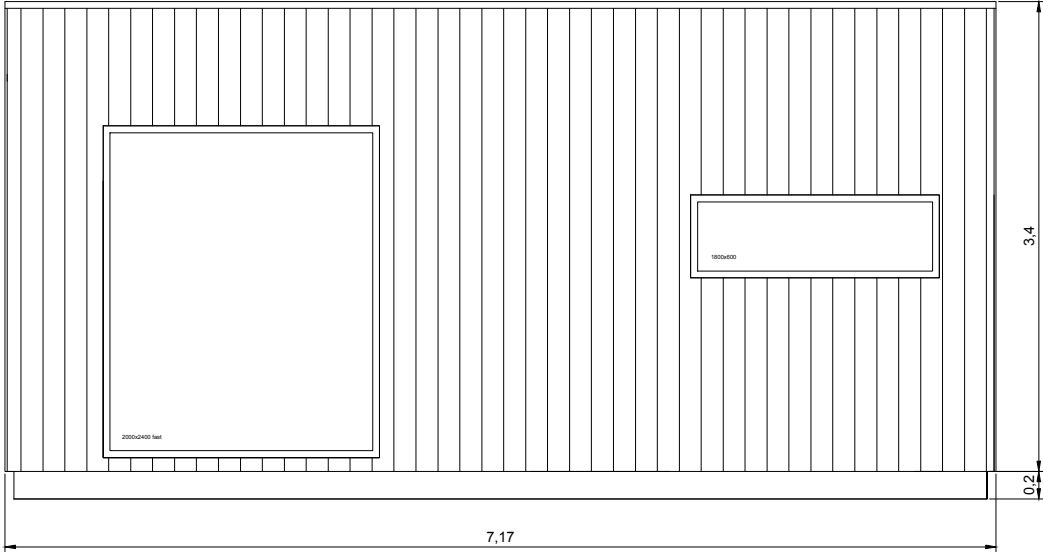

meter



Planritning

Ritningar nr. A002

Rev.

23/02

Skals 1:100

Ritad: Hus i bergslagen

Höger sida

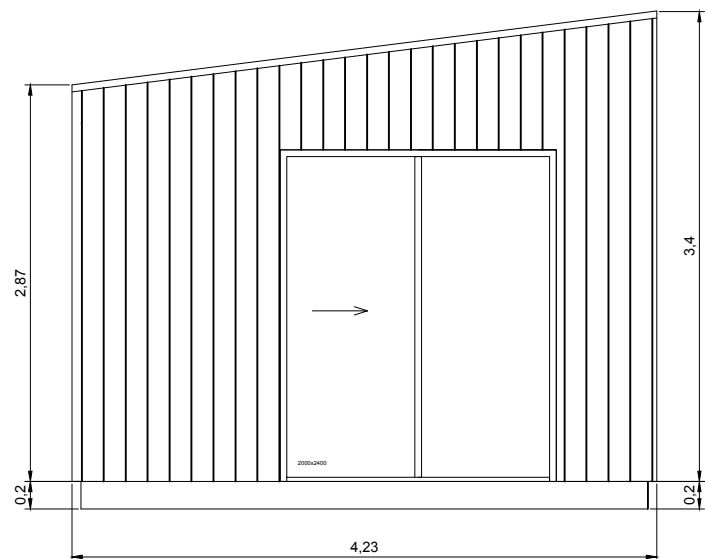

meter

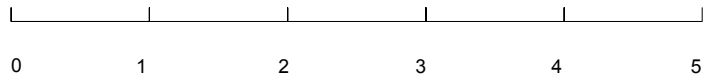

Planritning

Ritningar nr. A003

Rev.

23/02

Skals 1:100

Ritad: Hus i bergslagen

Vänster sida



meter

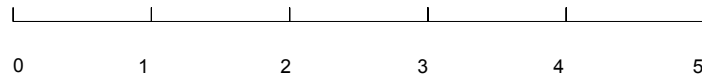

Planritning

Ritningar nr. A004

Rev.

23/02

Skals 1:100

Ritad: Hus i bergslagen

Plan ritning

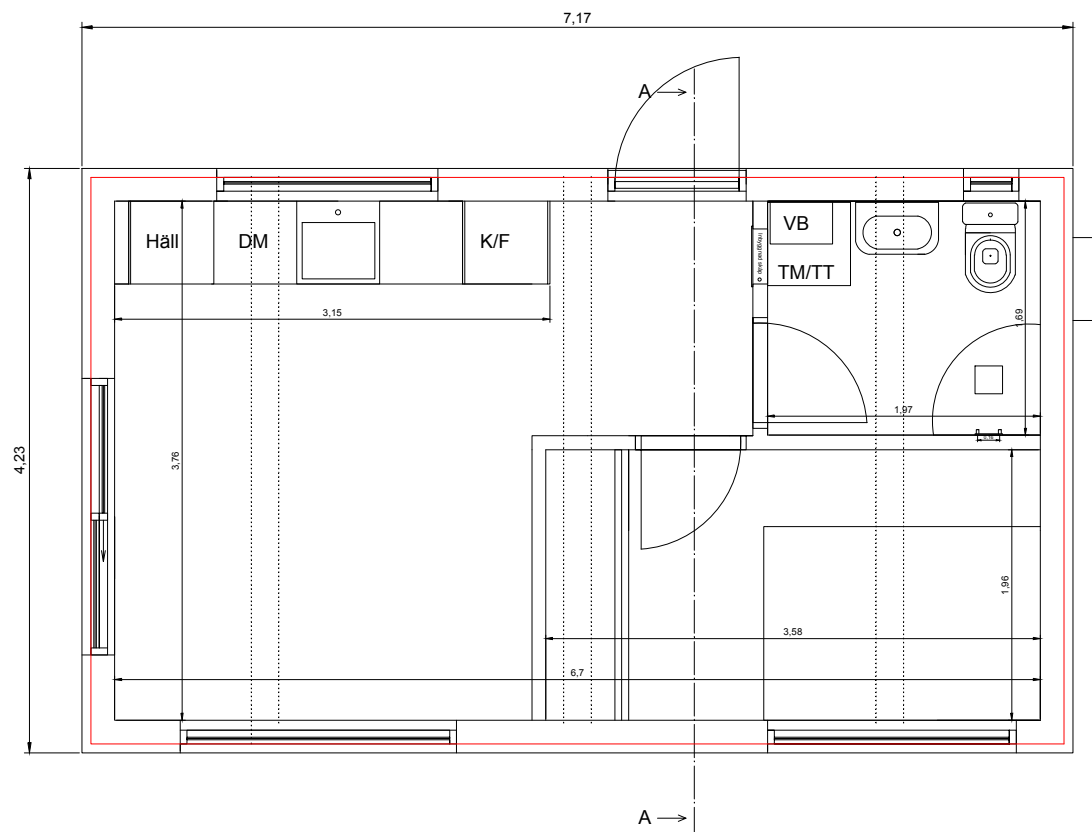

meter

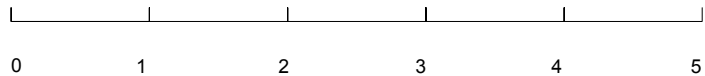

Planritning

Ritningar nr. A005

Rev.

23/02

Skals 1:100

Ritad: Hus i bergslagen

A - A sektion

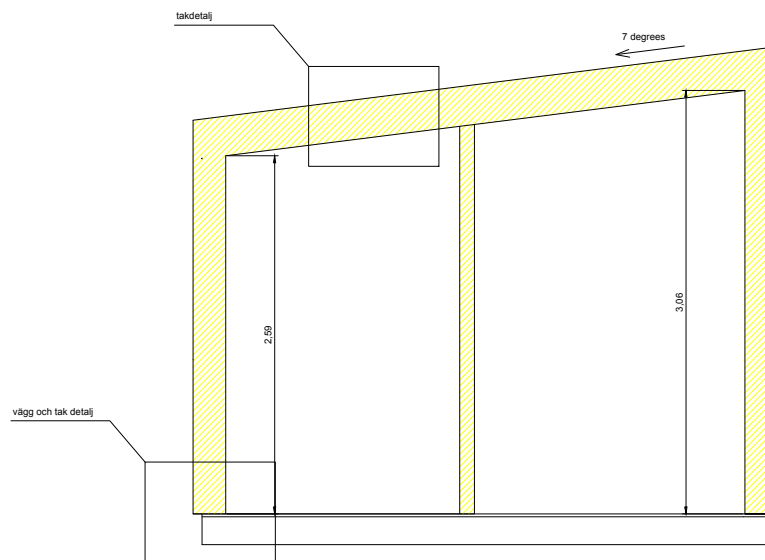

meter

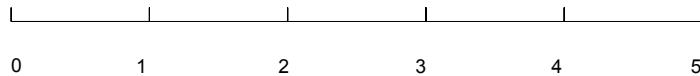

Planritning

Ritningar nr. A006

Rev.

23/02

Skals 1:100

Ritad: Hus i bergslagen

vägg och golv detail

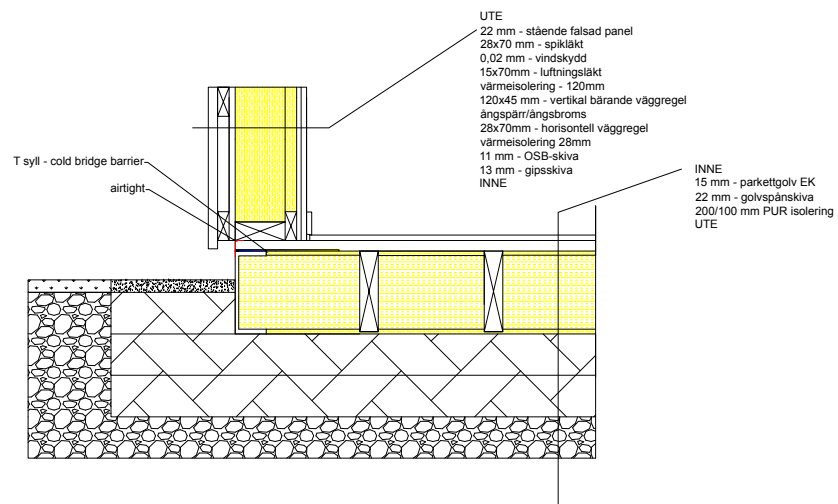

tak detail

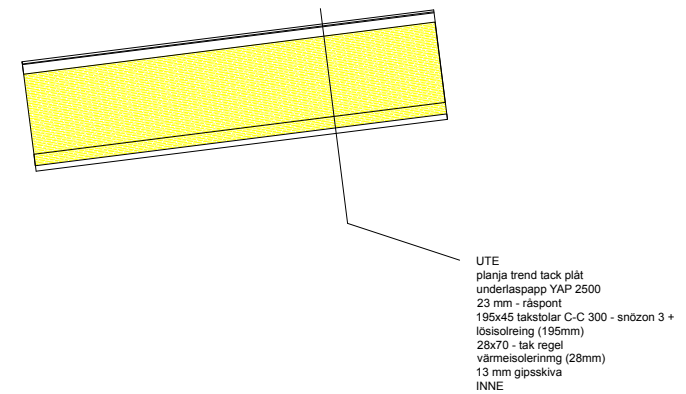

Planritning

Ritningar nr. A007

Rev.

23/02

Skals 1:100

Ritad: Hus i bergslagen

bjärklagg isolering

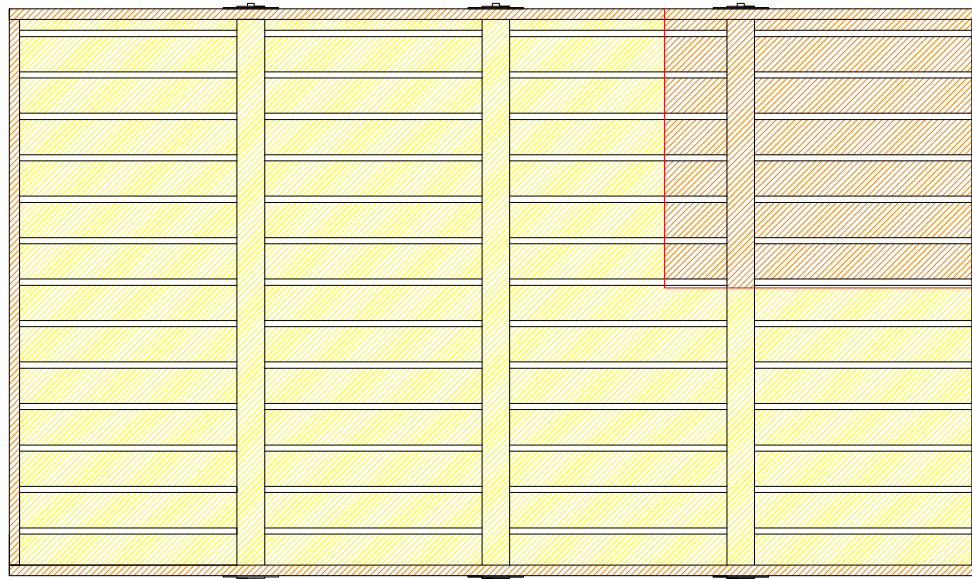

 PUR isolering 100mm, lamda = 0.022

 PUR isolering 200mm, lamda = 0.022

meter

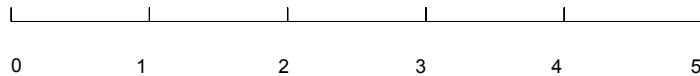

Planritning

Ritningar nr. A008

Rev.

23/02

Skals 1:100

Ritad: Hus i bergslagen